



Apple TV/FM Radio System





Basics

Apple TV/FM Radio System





Overview

The Apple TV/FM Radio System consists of a plug-in card with TV and FM radio tuners, plus control software. Connectors on the back of the tuner card allow attaching cable TV or antenna feedlines. An FM antenna is included.

The TV control software combines the familiarity of standard television controls with new features, like entering channel descriptions, setting program alerts, and locking channels with password protection. Closed captioning is available to watch programs without disturbing others or to monitor newscasts while listening to the radio. It's possible to shrink the TV window to one corner of the screen to free up space on the Macintosh desktop, or expand it to full size for easy viewing from across the room, or set it to any size in between.





The TV and FM radio applications can run at the same time. If two speakers are built into or attached to the Macintosh system, radio and TV programs will be in stereo.

There's also a remote-control unit that allows changing TV and radio stations, adjusting the volume, and controlling the CD player in a Macintosh system.

The Apple TV/FM Radio System works with the Apple Video System to help perform multimedia tasks, such as capturing and saving still frames, video clips, or audio. These can then be pasted into presentations, reports, and letters. Audio and video can be played back with any application that supports Apple's QuickTime multimedia technology.





Features

Components of the Apple TV/FM Radio System include:

- Plug-in card with TV and FM radio tuners
- Control software
- Handheld remote control (batteries included)
- Indoor antenna

TV/FM Radio System features that enhance the multimedia capabilities of a computer allow users to:

- Watch TV in a window or listen to the radio while working on the computer.
- Make documents with audio and video clips.
- View up to 181 television channels.
- Enjoy full FM broadcast band coverage.





Features that make the TV/FM Radio System easy to use include:

- Control programs that look like familiar television and car-radio front panels
- Single-click startup for control programs
- One-button capture for images, video clips, and sound

Customizable features enable users to:

- Enter descriptions on radio buttons and TV lists
- Assign passwords to prevent children from accessing specific TV channels
- Set reminders for favorite programs
- Resize the TV window to take up just as much or as little screen space as desired





Specifications

Apple TV/FM Radio System





TV Tuner

Channels

Up to 181

F connector

Permits connection of

- Antenna feedline (the indoor antenna provided for the FM tuner can also pick up strong TV signals)
- Standard or harmonically related carrier (HRC) cable TV feedline





Apple Video Player Software

Window Size

Variable:

- Smallest (about 1/16 of screen)
- Normal (about 1/4 of screen)
- Largest (as much of screen as possible)
- Any user-defined size between the smallest and largest options





Channel Presets

Up to 125

- Pop-up menu lets the user assign a description (such as station name, network affiliation, or type of programming) to each channel
- Each description can have as many as 15 characters

Auto Tune Function

Automatically adds all clearly received channels to the channel list (channels can also be added and deleted manually)





Push-Button Controls

Video Source Selection

TV tuner
Composite video
S-video

Video Standard Selection

NTSC
PAL
SECAM

Audio Mode Selection

Stereo
Mono
SAP (second audio program channel for descriptive video or
foreign language translations)





Sliding Controls

Video Adjustment

Brightness
Sharpness
Contrast
Color

Audio Adjustment

Volume
Balance
Treble response
Base response

Up/Down Buttons

For channel selection

Video Capture

One-click operation for capturing still frames or video clips





Movie Compression Optional

**Closed Captioning/
Video Text** CC 1
 CC 2
 Text 1
 Text 2

Reminders Function Lets the user store up to 25 program reminders. On-screen alert box appears at the program start time. The user can also request a notification prior to the beginning of the program. (Apple Video Player does not have to be running for the alert box to appear.)





Lockout

With password protection
On any channel
Optional

**“Hot Key”
Capability**

Instantly makes Apple Video Player the active program on your system.





FM Radio Tuner

Frequency Range

U.S.: 88.1–107.9 MHz
Europe: 88.1–107.9 MHz
Japan: 76.0–90.0 MHz

F Connector

Permits connection of

- Indoor antenna provided with system
- Standard cable TV connector (for cable systems that offer FM stations)





Apple FM Radio Player Software

Six Preset Buttons	For instant access to stations
User-Selectable Button Labels	Number (1 through 6) Frequency Station name Description, such as type of programming (maximum 4–6 characters, depending on character width)
Pop-Up Station Selection Menu	Can be labeled with frequency, station name, and description (maximum 31 characters)
Auto Add Function	Finds clear stations and adds them to pop-up menu.



**Manual Tuning
Functions**Seek up/down
Step up/down**Volume Control**

Sliding

Menu OptionsSignal range (Local, DX)
Signal strength (All Stations, All Except Weakest, Strong,
Strongest Only)
Audio mode (Stereo, Mono)**One-Click
Recording**Adjustable compression ratio/sampling rate
Record time indicator



Remote Control

Infrared Link

With Macintosh system

FM Radio Controls

Channel up/down (cycles among all preset stations)
Audio volume up/down
Audio mute

TV Controls

Channel up/down (cycles among all preset stations)
Audio volume up/down
Audio mute
TV window size (switches between current and largest size or previous size, if current size is the largest)
TV/Macintosh (launches or quits out of the Apple Video Player application)





CD-ROM Controls

Audio volume up/down

Audio mute

Play/pause

Stop/eject

Previous track

Next track

Macintosh Controls

Power on/off

TV/Macintosh





System Requirements

Any Apple Macintosh Computer

With a video-in slot and a port for an internal TV tuner card (refer to the technical specifications for your Macintosh system)

Note: Macintosh 5200 and 5300 series computers may require the purchase of a new back panel (Apple part number 620-0854).

Apple Video-In Card

Included with some Macintosh systems or can be purchased separately with the Apple Video System)

TV Antenna or Cable TV Feedline

With F connector





Upgrades

Apple TV/FM Radio System





TV/FM Tuner Card

To install the TV/FM tuner card, first attach it to the computer, and then connect an FM antenna and a TV antenna (or cable service connection) to it. Detailed instructions are in the following sections.

Note: The remote control or FM antenna may look different from those items pictured here.

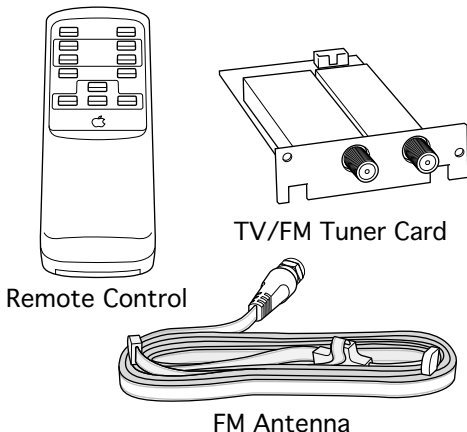



Video Input Card

Important: The TV portion of the TV/FM tuner card will **not** work if a video input card is not installed. Look at the back of the computer for the ports indicated in the diagram. If these ports are present, a video input card has already been installed.

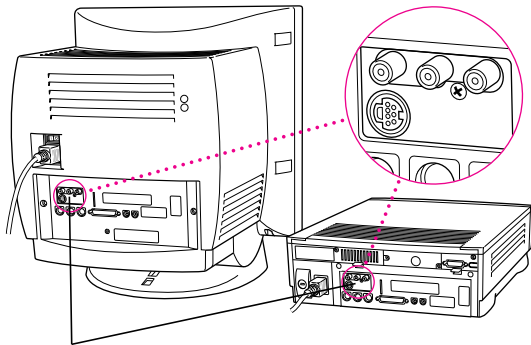

Video Input Card Ports

A video input card is required, even if the user does not intend to connect any video equipment, such as a VCR or video camera.





Installing in a Compact Computer

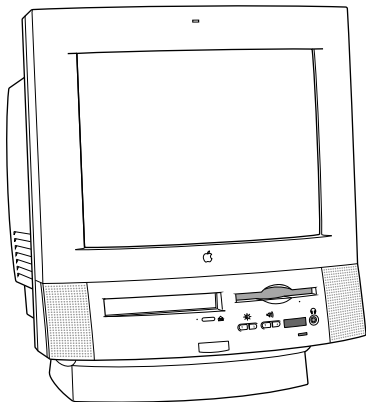

Note: If the computer has a built-in monitor like the one pictured here, follow the instructions in this section.





Remove the Logic Board

Important: Check the back of the computer for the rectangular TV/FM tuner card access cover pictured here. If the computer has a small circular access cover, obtain the proper I/O door (order P/N 922-2190) before continuing.

Caution: Review the ESD precautions in Bulletins/ Safety.

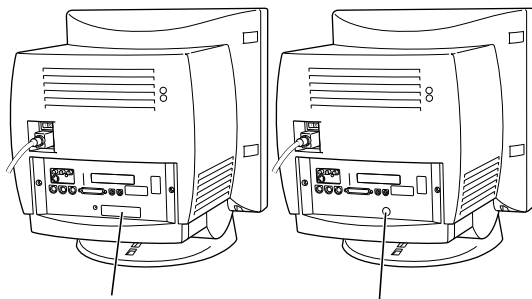

Rectangular Access
Cover

Small Circular
Access Cover





- 1 Remove the three screws that secure the I/O door.

Note: If the I/O door does not have a rectangular TV/FM tuner card access cover, there will be only two screws.

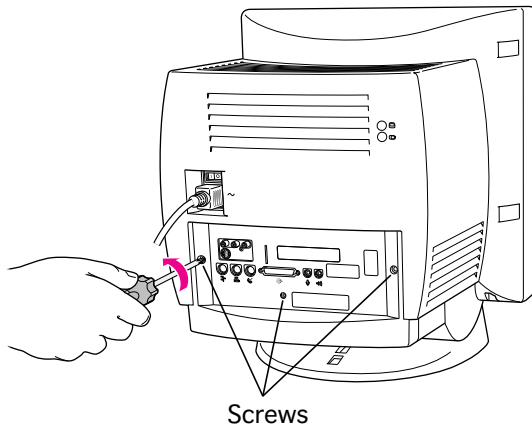



- 2 Locate the latches under the computer's case.

Two Latches

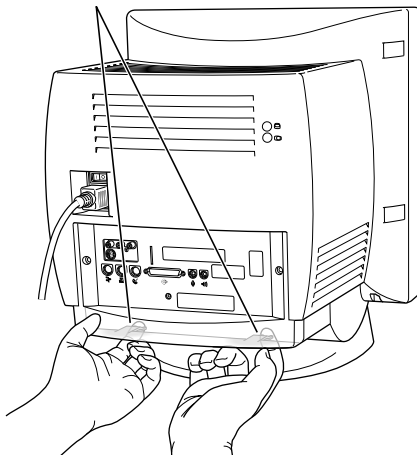



- 3 Pull gently to remove the I/O door.

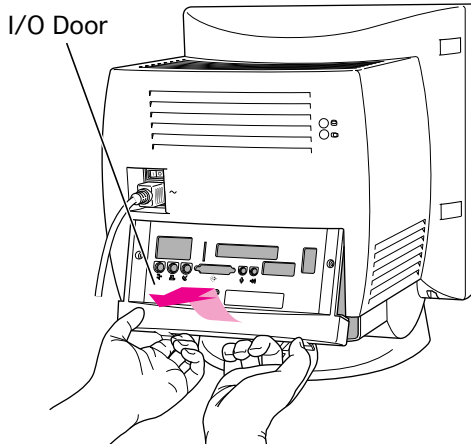



- 4 Pull down the wire handle and remove the logic board.

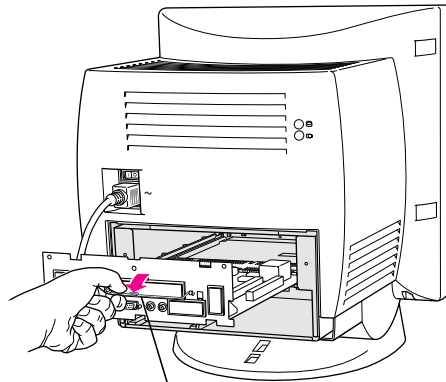

Wire Handle





Install the TV/FM Tuner Card

- 1 Pull gently on the ribbon cable under the logic board tray to bring it part way out of the opening.

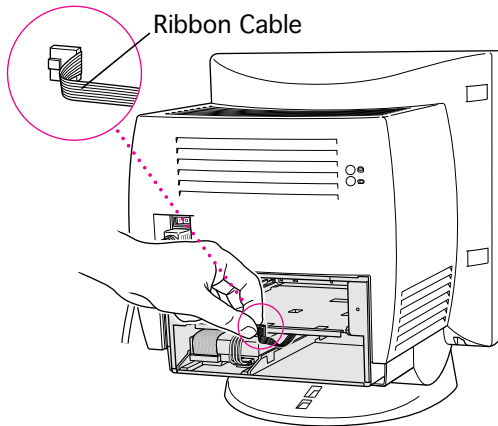



- 2 Attach the plug on the ribbon cable to the connector on the TV/FM tuner card.

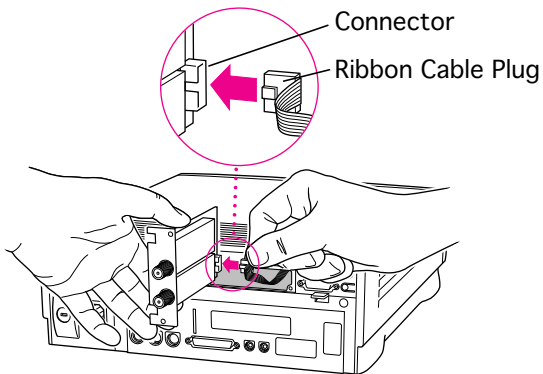



- 3 Slide the TV/FM tuner card along the guides into place under the logic board tray. Verify that the notches on the card point upward.

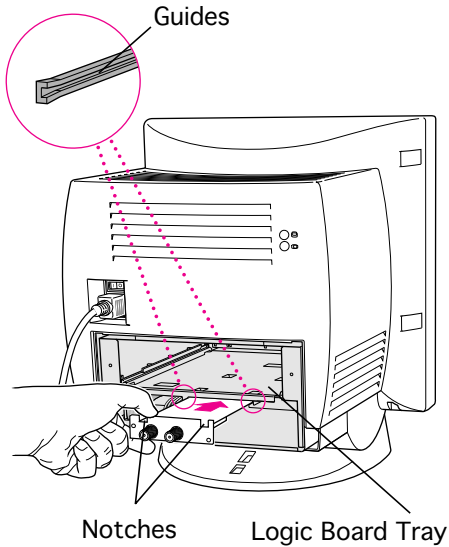



- 4 Locate the TV/FM tuner card access cover on the inside of the I/O door.

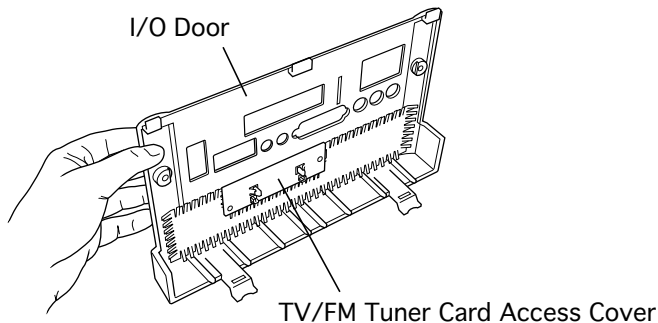



- 5 Squeeze the plastic tabs together and remove the metal retainer to free the access cover.

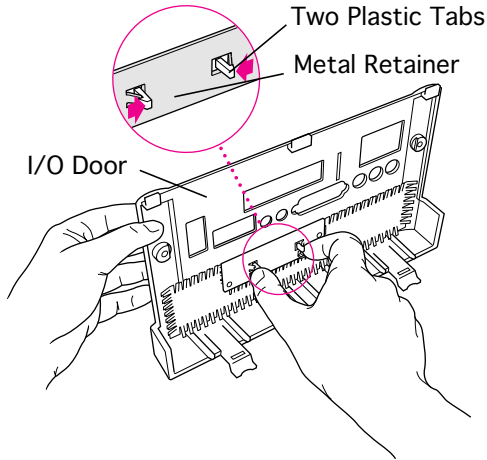



Replace the Logic Board

- 1 Replace the wire handle in its storage position under the catch.
- 2 Slide the logic board part way into the computer along the guide rails.

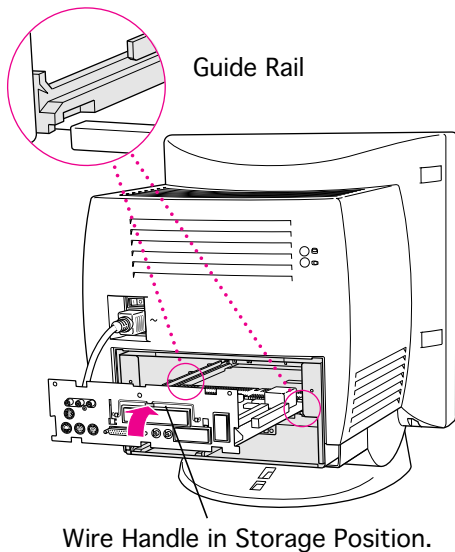

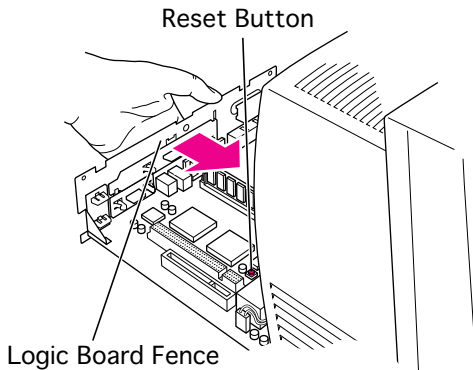

- Note:** In some computers, the reset button may be located in a different place from that pictured here.

Press the reset button on the logic board.

- Push the logic board fence until the logic board is firmly in place.





- 5 Align the tabs at the top of the I/O door with the grooves in the computer case.

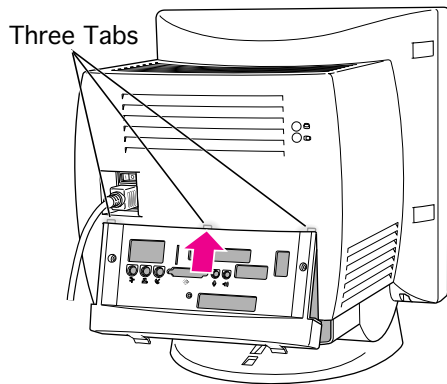



- 6 Press the I/O door into place.

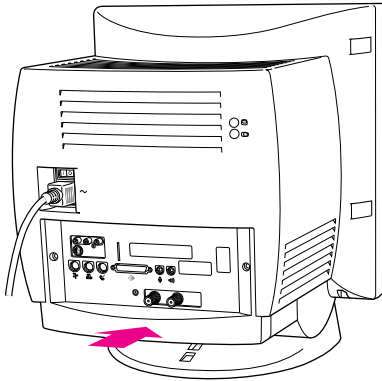



- 7 Replace the screw that secures the TV/FM tuner card.

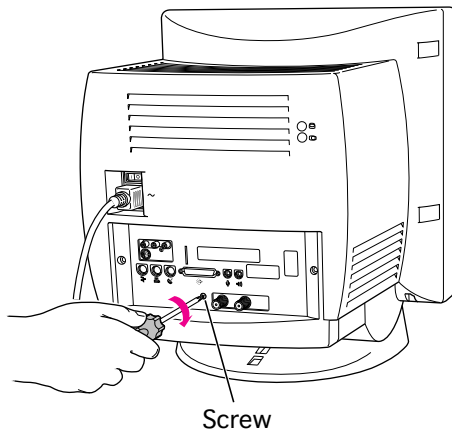



- 8 Replace the security screws on both sides of the I/O door.

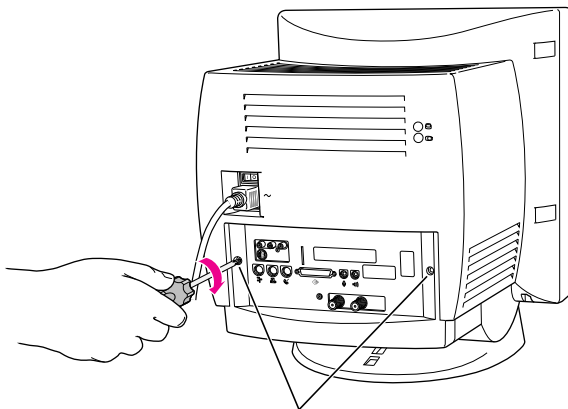

Security Screws





Installing in a Modular Computer

Note: If the computer has a separate monitor like the modular computer pictured here, follow the instructions in this section.

Caution: Review the ESD precautions in Bulletins/ Safety.

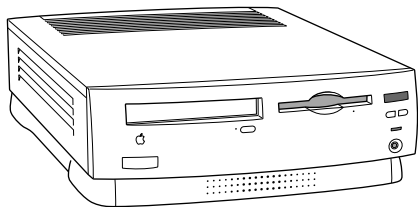



- 1 Remove the screws that secure the TV/FM tuner card access cover.
- 2 Pull off the access cover.

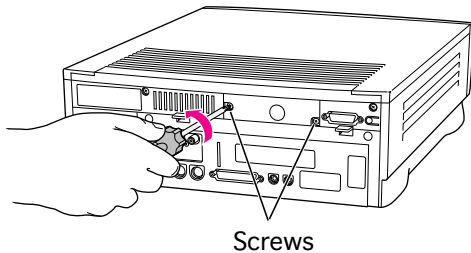



- 3 Gently pull the ribbon cable a short way out of the opening.

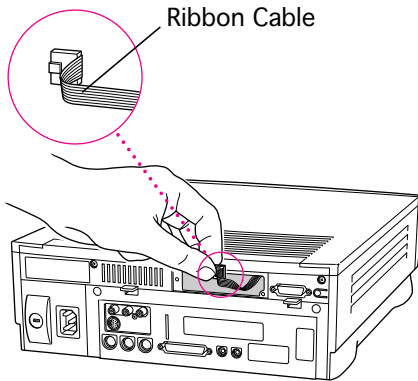



- 4 Insert the ribbon cable plug into the connector on the back of the card.

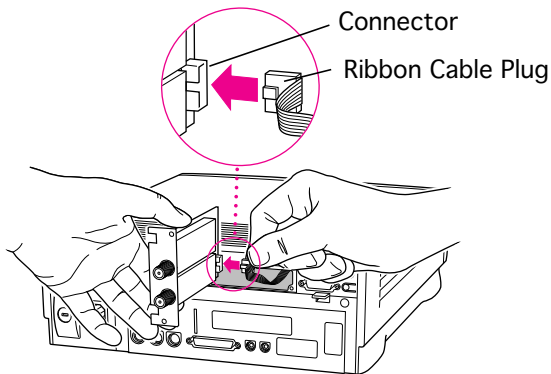



- 5 Slide the TV/FM tuner card along the guide rails on both sides of the opening. Verify that the ribbon cable is under the card and completely inside the access hole.

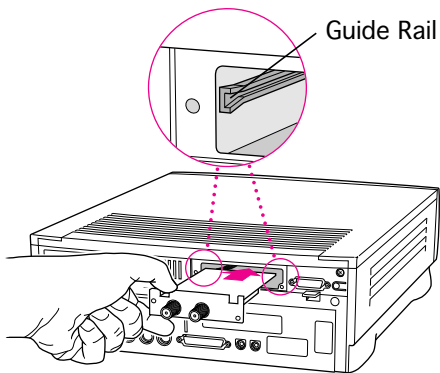



- 6 Replace the screws that secure the TV/FM tuner card to the computer.

